

Digital Stainless Steel Eye Point - UNC Thread Model No. 8-S292

Main Features

- Rotates through 360° adjustable in the direction of the load
- Manufactured from stainless steel
- Tested in accordance with EN1677-1
- Individual forged parts and cap screw are traceable to Test Certification
- Bolts are UNC thread
- Proof tested to 2.5 times the WLL
- Fatigue rated to 20,000 cycles at 1.5 times the WLL
- All YOKE Lifting points meet or exceed all the requirements of ASME B30.26
- Quick and simple assembly, just a tapped hole is required
- Used in different applications such as chemical, oil, coal industries, food processing, clean room and precision instrument.



Certification:

Each unit comes fully certified with a test certificate or an EC Declaration of Conformity stating compliance with the essential health and safety requirements of the Machinery Directive 2006/42/EC, the Supply of Machinery (Safety) Regulations 2008 and Section 6 of the Health and Safety at Work Etc Act 1974.





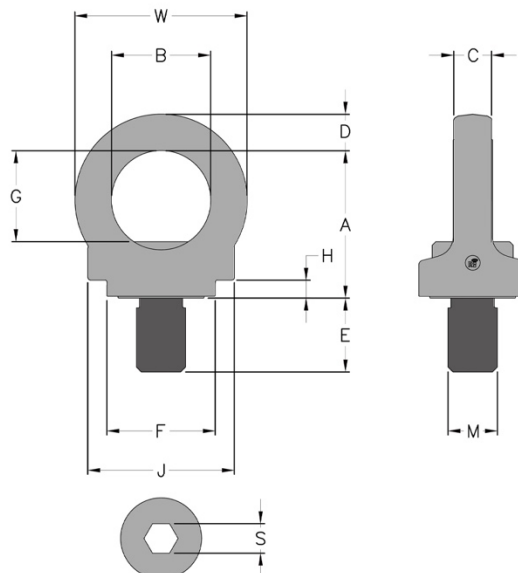

Manufactured and tested in accordance with EN1677-1. All YOKE Lifting points meet or exceed all the requirements of ASME B30.26.

Technical Data

Product Code	Capacity (tonne)	Thread version		Pitch	Dimensions (inch)										Torque in (Nm)	Net Weight (lbs)
		M (inch)	E (inch)		DIN13	A	B	C	D	F	G	H	J	S		
8-S292-005	0.5	1/2	0.75	13UNC	1.77	1.18	0.39	0.43	1.30	1.14	0.20	1.73	0.31	0.31	10	0.4
8-S292-010	1.0	5/8	0.94	11UNC	2.05	1.38	0.55	0.51	1.38	1.30	0.20	2.01	0.39	0.39	30	0.7
8-S292-020	2.0	3/4	1.40	10UNC	2.36	1.57	0.63	0.59	1.73	1.46	0.28	2.36	0.47	0.47	70	1.3
8-S292-025	2.5	1	1.52	8UNC	2.83	1.93	0.75	0.71	2.05	1.81	0.39	2.83	0.55	0.55	150	2.2

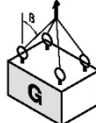
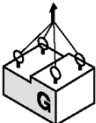

Our innovation, your safety

Kind of attachment											
Number of legs	Load direction	1	2	1	2	2	2	2	3-4	3-4	3-4
		0°	0°	90°	90°	0-45°	45°-60°	unsymm.	0-45°	45°-60°	unsymm.
Product Code	Thread	WLL (t)									
8-S292-005	1/2	1.2	2.4	0.5	1	0.7	0.5	0.5	1.0	0.7	0.5
8-S292-010	5/8	2.4	4.8	1.0	2	1.4	1.0	1.0	2.1	1.5	1.0
8-S292-020	3/4	3.6	7.2	2.0	4	2.8	2.0	2.0	4.2	3.0	2.0
8-S292-025	1	5.2	10.4	2.5	5	3.5	2.5	2.5	5.3	3.7	2.5

Due to our policy of continual product development, dimensions, weights and specifications may change without prior notice. Please check with your Tiger sales team when ordering.