

Tiger Heavy Duty Beam Clamp Model No. BC



Main Features

- Range from 1.0t to 10.0t
- Quick and versatile rigging point for hoisting equipment
- Low headroom because of the built in anchor point
- Multidirectional adjusting screw spindle for easy attachment and safe and secure grip
- Wide Beam flange adjustment range
- Operating temperature -40°C to +80°C (temperature range of -60°C to +80°C available as an option)
- 5:1 factor of safety – for straight pulling and lifting
- Optional locking device

These units meet and exceed all the requirements within BS EN 13155:2003+A2:2009 and AS4991.

Certification:

Each unit comes fully certified with a test certificate or an EC Declaration of Conformity stating compliance with the essential health and safety requirements of the Machinery Directive 2006/42/EC.

We hold complete technical files for our products to provide full back-up and reassurance on our products' performance and to ensure that advice for our equipment is readily available.

Technical Data

Product Code	Capacity (tonne)	Dimensions (mm)									Net Weight (kg)
		A	B	C	D	E	F	G	J	T	
BC-0100	1.0	75-210	182-328	77	24	195	144-117	52-38	20	5	4.0
BC-0200	2.0	75-210	182-328	85	24	195	144-117	52-38	20	6	4.5
BC-0300	3.0	75-305	214-460	107	25	250	224-179	58-40	22	8	8.0
BC-0500	5.0	75-305	214-460	121	25	250	224-175	58-40	28	10	10.0
BC-1000	10.0	120-350	295-510	181	30	300	222-171	71-54	43	16	24.5

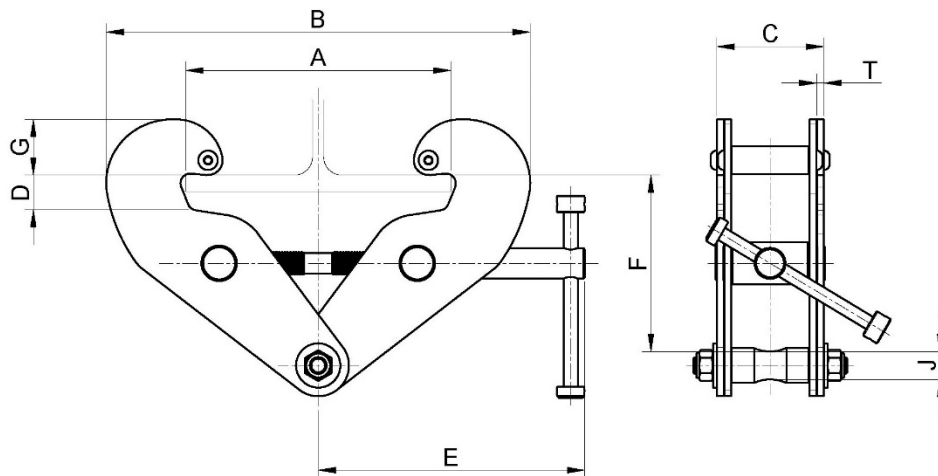

Due to our policy of continual product development, dimensions, weights and specifications may change without prior notice. Please check with your Tiger sales team when ordering.